



WARRANTY

LIMITED WARRANTY

Aroma Housewares Company warrants this product free from defects in material and workmanship for two years from provable date of purchase in the United States.

Within this warranty period, Aroma Housewares Company will repair or replace, at its option, defective parts at no charge, provided the product is returned, freight prepaid with proof of purchase and U.S. \$16.00 for shipping and handling charges payable to Aroma Housewares Company. Before returning an item, please call the toll free number below for a return authorization number. Allow 2-4 weeks for return shipping.

This warranty does not cover improper installation, misuse, abuse or neglect on the part of the owner. Warranty is also invalid in any case that the product is taken apart or serviced by an unauthorized service station.

This warranty gives you specific legal rights, which may vary from state to state, and does not cover areas outside the United States.

AROMA HOUSEWARES COMPANY
6469 Flanders Drive
San Diego, California 92121
1-800-276-6286
M-F, 8:30 AM - 4:30 PM, Pacific Time
Website: www.AromaCo.com

SERVICE & SUPPORT

In the event of a warranty claim, or if service is required for this product, please contact Aroma® customer service toll-free at:

1-800-276-6286
M-F, 8:30AM-4:30PM, Pacific Time

Or we can be reached online at CustomerService@AromaCo.com.

For your records, we recommend stapling your sales receipt to this page along with a written record of the following:

Date of Purchase: _____

Place of Purchase: _____



NOTE

- Proof of purchase is required for all warranty claims.

AROMA®

PROFESSIONAL™

Instruction Manual

Rice Cooker | Food Steamer | Slow Cooker



Questions or concerns about your rice cooker?

Before returning to the store...



Aroma's customer service experts are happy to help. Call us toll-free at **1-800-276-6286**.



Answers to many common questions and even replacement parts can be found online. Visit **www.AromaCo.com/Support**.





With the Aroma® Professional™ Rice Cooker/Food Steamer/Slow Cooker you'll be making fantastic, restaurant-quality rice at the touch of a button! This machine is specially calibrated to cook all varieties of rice, including tough-to-cook brown rice, to fluffy perfection. There's no stirring or monitoring, just delicious rice made automatically!

In addition to restaurant-quality rice, your new Aroma® Professional™ Rice Cooker is ideal for cooking complete, healthy meals. The convenient steam tray inserts directly over the rice, allowing you to cook meats and vegetables at the same time, in the same pot. Steaming food locks in natural flavors and nutrients that are often lost with other methods of cooking. And with the Smart Steam feature, steaming favorite meats and vegetables has never been easier. Program the number of minutes needed to steam and the Smart Steam feature does the rest.

The new advanced Slow Cook feature includes both a "High" and "Low" setting to transform your rice cooker into a programmable 3-quart slow cooker! It sets from 2 to 10 hours to easily prepare all of your family's slow-cooked favorites. And once the cooking time has passed, the rice cooker will automatically go into "Keep-Warm," so there's no need to worry about an over-cooked meal.

Your new rice cooker is also great for making soups, stews, stocks, oatmeal, gumbos, jambalaya, breakfast frittatas, dips and even desserts! See the included recipe booklet for great meal ideas.

This manual contains helpful measurement charts for cooking rice and steaming. For more information on your Aroma® Professional™ Rice Cooker/Food Steamer/Slow Cooker, or for more recipes, replacement parts, product service and other home appliance solutions, please visit us online at www.AromaCo.com.

Published By:
Aroma Housewares Co.
6469 Flanders Drive
San Diego, CA 92121
U.S.A.
1-800-276-6286
www.AromaCo.com
©2011 Aroma Housewares Company
All rights reserved.



ABOUT RICE

Courtesy of the USA Rice Federation

Did You Know?

- Rice is the primary dietary staple for more than half of the world's population.
- U.S. grown rice is the standard for excellence and accounts for nearly 88% of the rice consumed in America. It is grown and harvested by local farmers in five south-central states and California.
- Rice contains no sodium, cholesterol, trans fats or gluten, and has only a trace of fat. One half-cup of rice contains about 100 calories.
- Research shows that people who eat rice have healthier diets than non-rice eaters and eat more like the U.S. Dietary Guidelines for Americans recommendations.
- Whole grains like brown rice help reduce the risk of chronic diseases such as heart disease, diabetes and certain cancers, and aid in weight management.
- Brown rice is a 100% whole grain. One cup of whole grain brown rice provides two of the three recommended daily servings of whole grains.
- Eating rice triggers the production of serotonin in the brain, a chemical that helps regulate and improve mood.
- September is National Rice Month - promoting awareness of the versatility and the value of U.S. grown rice.

For recipes and rice information visit the USA Rice Federation online at www.usarice.com/consumer.





ABOUT RICE

Courtesy of the USA Rice Federation

Rice is the perfect foundation for today's healthier eating. It is a nutrient-dense complex carbohydrate that supplies energy, fiber, essential vitamins and minerals and beneficial antioxidants. Rice combines well with other healthy foods such as vegetables, fruits, meat, seafood, poultry, beans and soy foods.

Nearly 88% of rice consumed in the U.S. is grown in the U.S. Arkansas, California, Louisiana, Texas, Mississippi and Missouri produce high-quality varieties of short, medium and long grain rice as well as specialty rices including jasmine, basmati, arborio, red aromatic and black japonica, among others.

There are many different varieties of rice available in the market. Your Aroma® Rice Cooker can cook any type perfectly every time. The following are the commonly available varieties of rice and their characteristics:

Long Grain Rice

This rice has a long, slender kernel three to four times longer than its width. Due to its starch composition, cooked grains are more separate, light and fluffy compared to medium or short grain rice. The majority of white rice is enriched to restore nutrients lost during processing. Great for entrees and side dishes— rice bowls, stir-fries, salads and pilafs.

Medium Grain Rice

When compared to long grain rice, medium grain rice has a shorter, wider kernel that is two to three times longer than its width. Cooked grains are more moist and tender than long grain, and have a greater tendency to cling together. Great for entrees, sushi, risotto and rice puddings.

Short Grain Rice

Short grain rice has a short, plump, almost round kernel. Cooked grains are soft and cling together, yet remain separate and are somewhat chewy, with a slight springiness to the bite. Great for sushi, Asian dishes and desserts.

Brown Rice

Brown rice is a 100% whole grain food that fits the U.S. Dietary Guidelines for Americans recommendation to increase daily intake of whole grains. Brown rice contains the nutrient-dense bran and inner germ layer where many beneficial compounds are found. Brown rice is available in short, medium and long grain varieties and can be used interchangeably with enriched white rice.

Wild Rice

Wild rice is an aquatic grass grown in Minnesota and California and is a frequent addition to long grain rice pilafs and rice mixes. Its unique flavor, texture and rich dark color provide a delicious accent to rice dishes. Wild rice also makes a wonderful stuffing for poultry when cooked with broth and mixed with your favorite dried fruits.

For recipes and rice information visit the USA Rice Federation online at www.usarice.com/consumer.



IMPORTANT SAFEGUARDS

Basic safety precautions should always be followed when using electrical appliances, including the following:

- Important: Read all instructions carefully before first use.**
- Do not touch hot surfaces. Use the handles or knobs.
- Use only on a level, dry and heat-resistant surface.
- To protect against fire, electric shock and injury to persons, do not immerse cord, plug or the appliance in water or any other liquid. See instructions for cleaning.
- Close supervision is necessary when the appliance is used by or near children.
- Unplug from outlet when not in use and before cleaning. Allow unit to cool before putting on or taking off parts and before cleaning the appliance.
- Do not operate any appliance with a damaged cord or plug or after the appliance malfunctions or has been damaged in any manner. Contact Aroma® customer service for examination, repair or adjustment.
- The use of accessory attachments not recommended by Aroma® Housewares may result in fire, electrical shock or injury.
- Do not use outdoors.
- Do not let cord touch hot surfaces or hang over the edge of a counter or table.
- Do not place on or near a hot burner or in a heated oven.
- Do not use the appliance for other than its intended use.
- Extreme caution must be used when moving the appliance containing rice, hot oil or other liquids.
- Do not touch, cover or obstruct the steam vent on the top of the rice cooker as it is extremely hot and may cause scalding.
- Use only with a 120V AC power outlet.
- Always unplug from the base of the wall outlet. Never pull on the cord.
- The rice cooker should be operated on a separate electrical circuit from other operating appliances. If the electrical circuit is overloaded with other appliances, the appliance may not operate properly.
- Always make sure the outside of the inner cooking pot is dry prior to use. If the inner pot is returned to the cooker when wet, it may damage or cause the product to malfunction.
- Use extreme caution when opening the lid during or after cooking. Hot steam will escape and may cause burns.
- Rice should not be left in the inner pot with the "Keep-Warm" function on for more than 12 hours.
- To prevent damage or deformation, do not use the inner pot on a stovetop or burner.
- To disconnect, turn any control to "OFF," then remove the plug from the wall outlet.
- To reduce the risk of electrical shock, cook only in the removable inner cooking pot provided.

SAVE THESE INSTRUCTIONS

! IMPORTANT SAFEGUARDS

Short Cord Instructions

1. A short power-supply cord is provided to reduce the risks resulting from becoming entangled in or tripping over a longer cord.
2. Longer extension cords are available and may be used if care is exercised in their use.
3. If a longer extension cord is used:
 - a. The marked electrical rating of the extension cord should be at least as great as the electrical rating of the appliance.
 - b. The longer cord should be arranged so that it will not drape over the counter top or tabletop where it can be pulled by children or tripped over unintentionally.

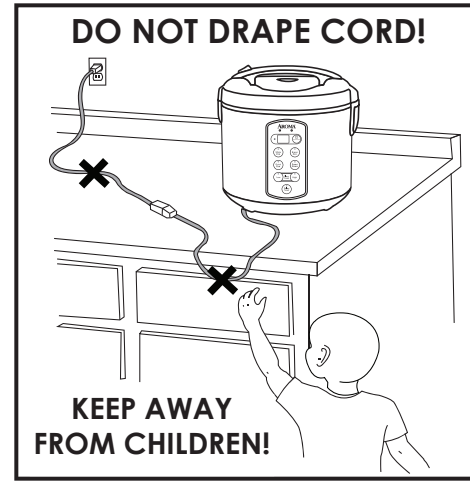

Polarized Plug

This appliance has a **polarized plug** (one blade is wider than the other); follow the instructions below:

To reduce the risk of electric shock, this plug is intended to fit into a polarized outlet only one way. If the plug does not fit fully into the outlet, reverse the plug. If it still does not fit, contact a qualified electrician. Do not attempt to modify the plug in any way.

If the supply cord is damaged, it must be replaced by the manufacturer, its service agent or a similarly qualified person in order to avoid a hazard.

? TROUBLESHOOTING

Because rice varieties may vary in their make-up, results may differ. Below are some troubleshooting tips to help you achieve the desired consistency.

<p>Rice is too dry/hard after cooking.</p>	<p>If your rice is dry or hard/chewy when the rice cooker switches to “Keep-Warm” mode, additional water and cooking time will soften the rice. Depending on how dry your rice is, add ½ to 1 cup of water and stir through. Close the lid and press the QUICK RICE button. When rice cooker switches to “Keep-Warm” mode, open the lid and stir the rice to check the consistency. Repeat as necessary until rice is soft and moist.</p>
<p>Rice is too moist/soggy after cooking.</p>	<p>If your rice is still too moist or soggy when the rice cooker switches to “Keep-Warm” mode, use the serving spatula to stir the rice. This will redistribute the bottom (moistest) part of the rice as well as release excess moisture. Close the lid and allow to remain on “Keep-Warm” mode for 10-30 minutes as needed, opening the lid and stirring periodically to release excess moisture.</p>
<p>The bottom layer of rice is browned/ caramelized.</p>	<p>The bottom layer of cooked rice may become slightly browned and/or caramelized during cooking. To reduce browning, rice should be rinsed before cooking to remove any excess starch. Stirring rice once it switches to “Keep-Warm” will also help to reduce browning/caramelizing.</p>

HOW TO CLEAN

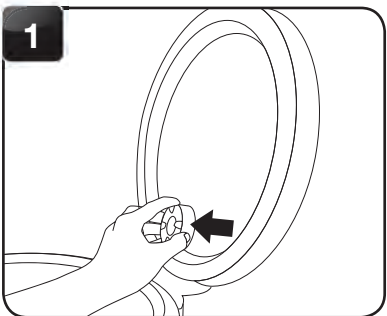

1 Remove the steam vent.

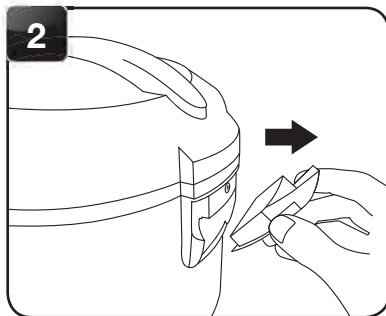

2 Remove the condensation collector.

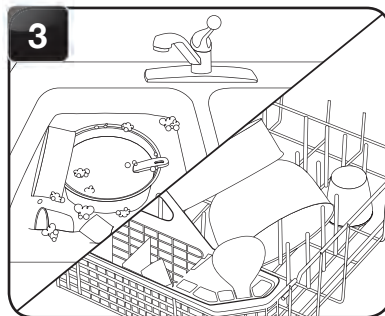

3 Handwash the inner cooking pot and all accessories or wash them in the dishwasher.



4 Wipe rice cooker body clean with a damp cloth.

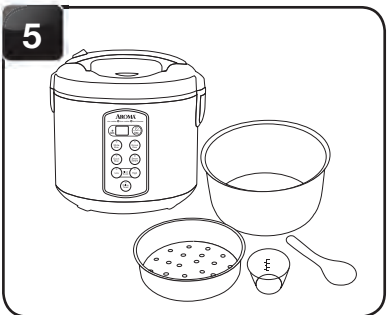

5 Thoroughly dry rice cooker body and all accessories.

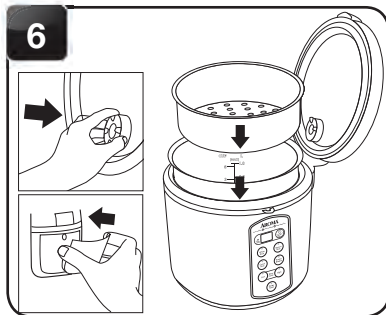

6 Reassemble for next use.



NOTE

- Do not use harsh abrasive cleaners, scouring pads or products that are not considered safe to use on nonstick coatings.
- If washing in the dishwasher, a slight discoloration to the inner pot and accessories may occur. This is cosmetic only and will not affect performance.
- Any other servicing should be performed by Aroma® Housewares. Contact Aroma® customer service at 1-800-276-6286, Monday to Friday 8:30AM-4:30PM PST.

PARTS IDENTIFICATION

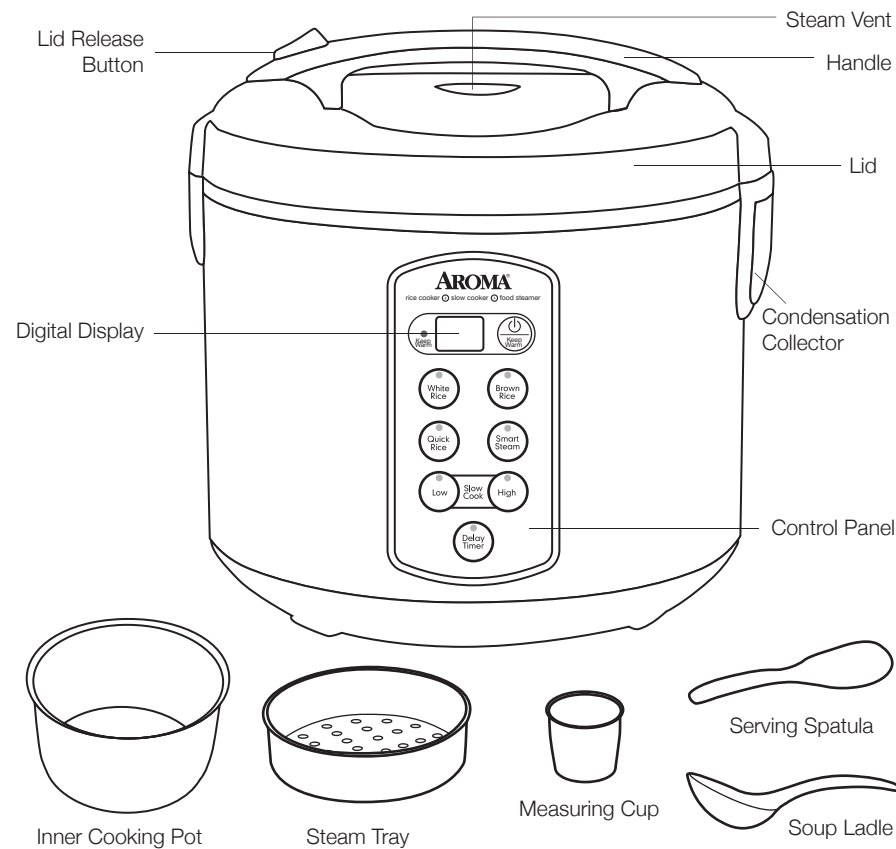

Digital Controls



Power/Keep-Warm Button

The POWER/KEEP-WARM button serves two purposes. One press of the POWER/KEEP-WARM button will turn the rice cooker "on." A second press will set the rice cooker to its "Keep-Warm" setting.



White Rice

The WHITE RICE button cooks restaurant-quality rice automatically.



Brown Rice

The BROWN RICE button is ideal for cooking brown rice and other tough-to-cook whole grains to perfection.



Quick Rice

The QUICK RICE button is a great time-saving option for rice in a pinch. This setting foregoes the rice cooker's Sensor Logic™ for faster cooking times, although cooked rice will not be to the same quality of the "White Rice" and "Brown Rice" functions.



Smart Steam

The SMART STEAM button is perfect for healthy sides and main courses. Set the time food needs to steam, it will begin to countdown once water reaches a boil and shut off once time has elapsed.



Low Slow Cook

The LOW slow cook button sets to slow cook from 6 to 10 hours and reaches about 200°F.



High Slow Cook

The HIGH slow cook button sets to slow cook from 2 to 5 hours and reaches about 210°F.



Delay Timer

The DELAY TIMER sets up to 15 hours for rice ready when it's needed. Add rice and water in the morning and set the timer for mealtime at night.



BEFORE FIRST USE

1. Read all instructions and important safeguards.
2. Remove all packaging materials and check that all items have been received in good condition.
3. Tear up all plastic bags as they can pose a risk to children.
4. Wash steam vent and all other accessories in warm, soapy water. Rinse and dry thoroughly.
5. Remove the inner cooking pot from rice cooker and clean with warm, soapy water. Rinse and dry thoroughly before returning to cooker.
6. Wipe body clean with a damp cloth.



NOTE

- Do not use abrasive cleaners or scouring pads.
- Do not immerse the rice cooker base, cord or plug in water at any time.



FOR QUICK SOUPS, STEWS AND CHILIS (CONT.)

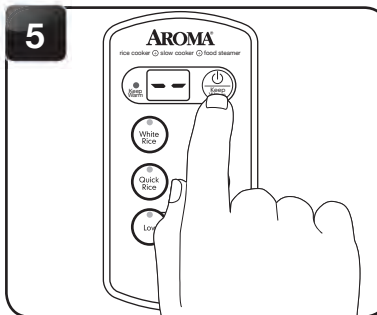

5 Press the **POWER/KEEP-WARM** button to turn the rice cooker on.

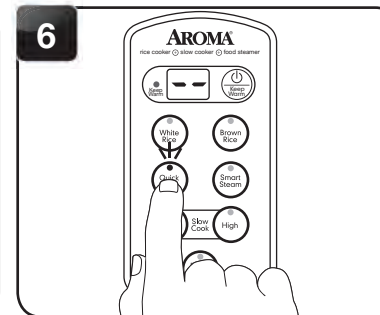

6 Press the **QUICK RICE** button to begin cooking.

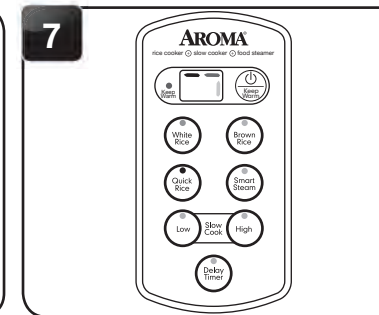

7 The digital display will show a "chasing" pattern to indicate it is cooking.

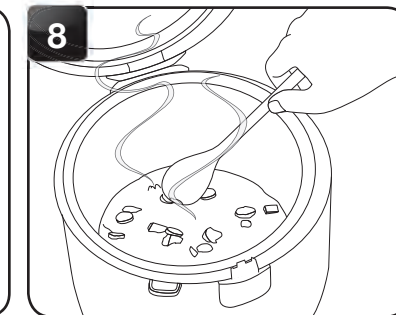

8 Using caution to avoid escaping steam, open the lid and stir occasionally with a long-handled wooden spoon.

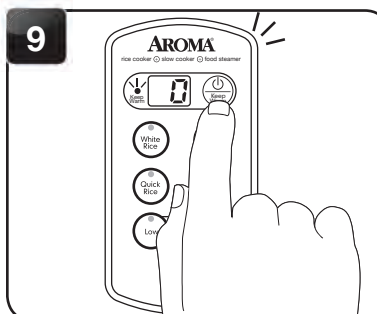

9 Once cooking is complete, press the **POWER/KEEP-WARM** button to switch the rice cooker to "Keep-Warm." The digital display will show the number of hours the rice cooker has been on "Keep-Warm," beginning with "0."

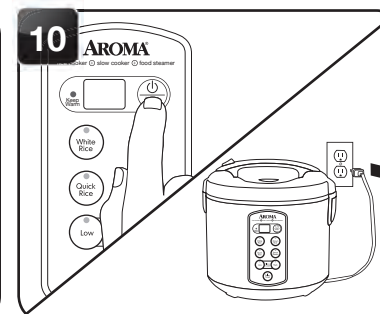

10 When finished serving, turn the rice cooker off by pressing the **POWER/KEEP-WARM** button once and unplug the power cord.



NOTE

- Food should not be left in the rice cooker on "Keep-Warm" for more than 12 hours.



FOR QUICK SOUPS, STEWS OR CHILIS

The rice cooker will not switch to "Keep-Warm" mode until all liquid is boiled away. Follow the recipe carefully and do not leave the rice cooker unattended.

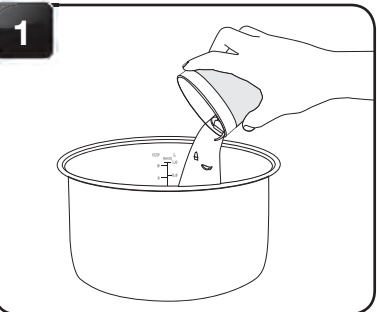

1 Add ingredients to the inner cooking pot.



2 Place the inner cooking pot into the rice cooker.

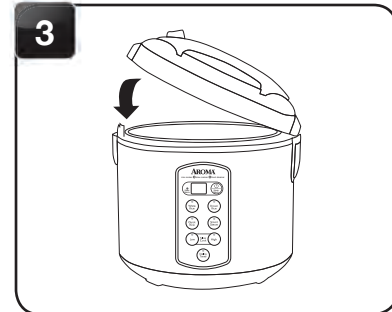

3 Close the lid securely.

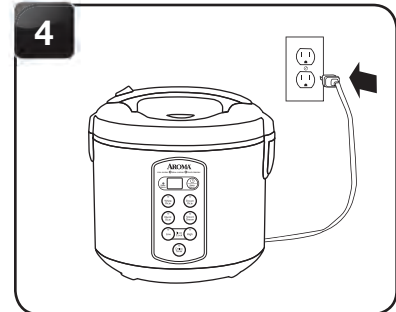

4 Plug the power cord into an available outlet.



TO COOK RICE

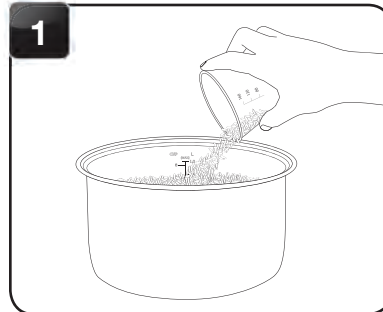

1 Using the provided measuring cup, add rice to the inner cooking pot.

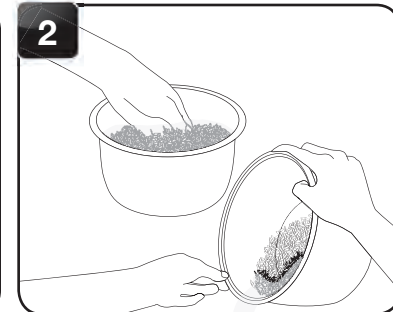

2 Rinse rice to remove excess starch. Drain.

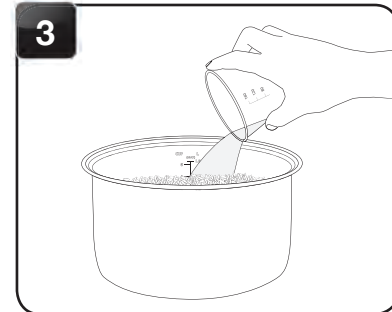

3 Fill with water to the line which matches the number of cups of rice being cooked. For example, if cooking two cups of uncooked rice, water should be filled to line 2 in the inner pot.

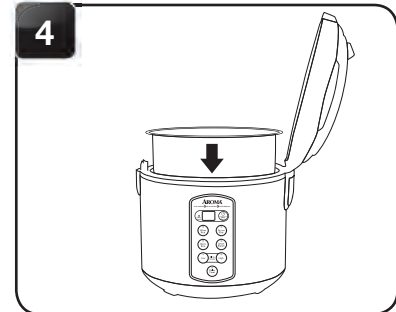

4 Place the inner cooking pot into the rice cooker.



NOTE

- Before placing the inner cooking pot into the rice cooker, check that the cooking pot is dry and free of debris. Adding the inner cooking pot when wet may damage the rice cooker.



HELPFUL HINTS

- If you misplace the measuring cup, a 3/4 standard US cup is an exact replacement.
- To add more flavor to rice, try substituting a favorite meat/vegetable broth or stock. The ratio of broth/stock to rice will be the same as water to rice.
- For approximate rice cooking times and suggested rice/water ratios, see the "Rice/Water Measurement Table" on **page 8**.



TO COOK RICE (CONT.)



Close the lid securely.

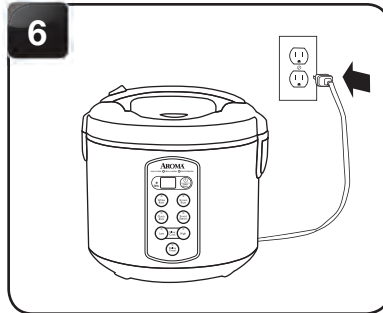

Plug the rice cooker into an available outlet.

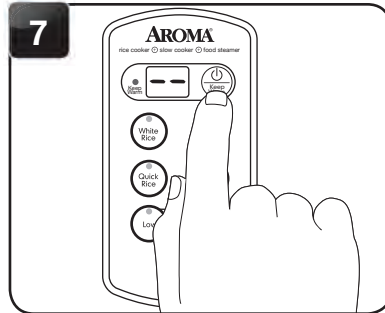

Press the **POWER/KEEP-WARM** button to turn on the rice cooker.

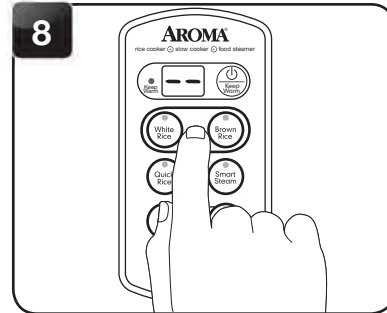

Press the **WHITE RICE** or **BROWN RICE** button, depending upon the type of rice being cooked.



NOTE

- Brown rice requires a longer cooking cycle than white rice due to the extra bran layers on the grain. If it appears the rice cooker is not immediately cooking this is due to the a low-heat soak cycle that precedes cooking to produce fluffier grains. The enhanced Sensor Logic™ of this rice cooker will cook brown rice up to 25% faster than other rice cookers.



HELPFUL HINTS

- Short on time? Use the "Quick Rice" function. See more details on this time-saving option on **page 9**.



STEAMING TABLES

When steaming, Aroma® recommends using 3 cups of water with the provided measuring cup.

Meat Steaming Table

MEAT	STEAMING TIME	SAFE INTERNAL TEMPERATURE
Fish	25 Min.	140°F
Chicken	30 Min.	165°F
Pork	30 Min.	160°F
Beef	Medium = 25 Min. Medium-Well = 30 Min. Well = 33 Min.	160°F

Vegetable Steaming Table

VEGETABLE	STEAMING TIME
Asparagus	20 Minutes
Broccoli	15 Minutes
Cabbage	25 Minutes
Carrots	25 Minutes
Cauliflower	25 Minutes
Corn	25 Minutes
Eggplant	30 Minutes
Green Beans	15 Minutes
Peas	20 Minutes
Spinach	20 Minutes
Squash	20 Minutes
Zucchini	20 Minutes



HELPFUL HINTS

- Since most vegetables only absorb a small amount of water, **there is no need to increase the amount of water with a larger serving of vegetables.**
- Steaming times may vary depending upon the cut of meat being used.
- To ensure meat tastes its best, and to prevent possible illness, check that meat is completely cooked prior to serving. If it is not, simply place more water in the inner cooking pot and repeat the cooking process until the meat is adequately cooked.



NOTE

- Altitude, humidity and outside temperature will affect cooking times.
- These steaming charts are for reference only. Actual cooking times may vary.

1 TO STEAM FOOD & SIMULTANEOUSLY COOK RICE (CONT.)

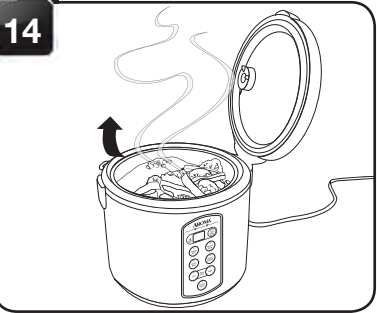

14 Using caution, open the lid to check food for doneness.



15 If food is finished steaming, carefully remove the steam tray. It will be hot.

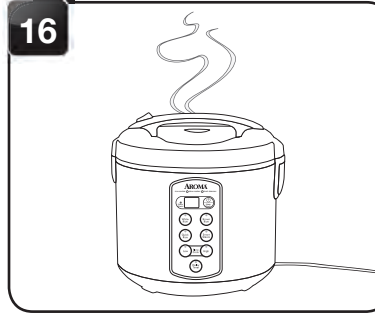

16 Allow the rice cooker to continue cooking rice.

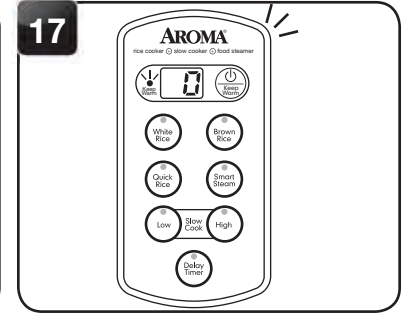

17 Once the selected time has passed, the rice cooker will beep and switch to "Keep-Warm" mode. The digital display will show the number of hours the rice cooker has been on "Keep-Warm," beginning with "0."

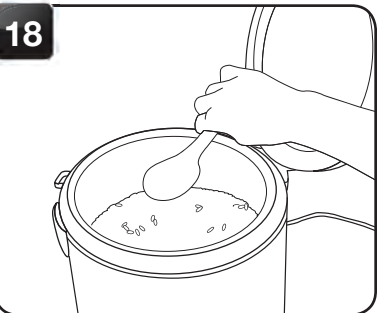

18 For best results, stir the rice with the serving spatula to distribute any remaining moisture.

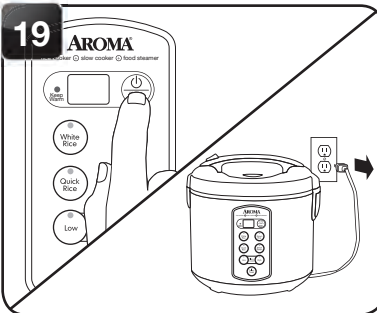

19 When finished serving rice, turn the rice cooker off by pressing the POWER/KEEP-WARM button and unplug the power cord.



- Rice should not be left in the rice cooker on "Keep-Warm" for more than 12 hours.

NOTE

TO COOK RICE (CONT.)

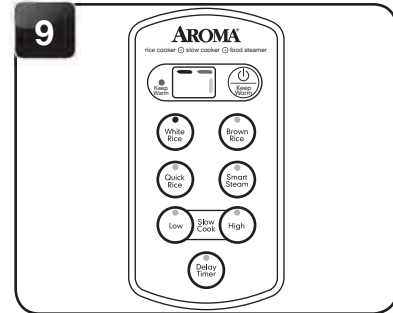

9 The rice cooker will begin cooking. The digital display will show a "chasing" pattern.

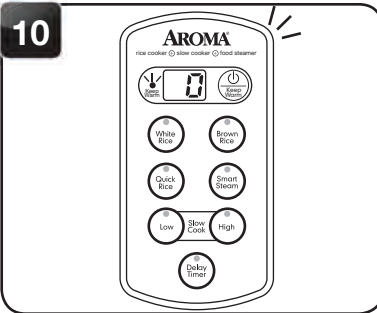

10 Once rice is finished, the rice cooker will beep and automatically switch to "Keep-Warm." The digital display will show the number of hours the rice cooker has been on "Keep-Warm," beginning with "0."

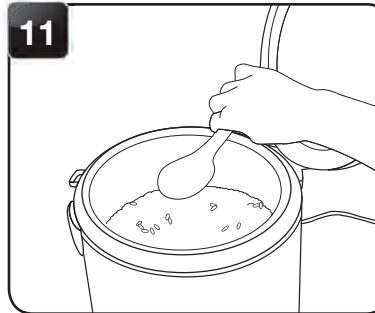

11 For better results, stir the rice with the serving spatula to distribute any remaining moisture.

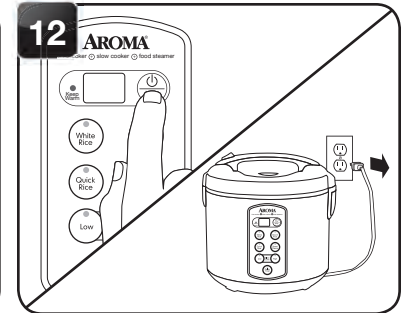

12 When finished serving rice, turn the rice cooker off by pressing the POWER/KEEP-WARM button and unplug the power cord.



- Rice should not be left in the rice cooker on "Keep-Warm" for more than 12 hours.

NOTE

RICE/WATER MEASUREMENT TABLE

UNCOOKED RICE*	RICE WATER LINE INSIDE POT	APPROX. COOKED RICE YIELD*	COOKING TIMES
2 Cups	Line 2	4 Cups	WHITE RICE: 30-35 Min. BROWN RICE: 65-70 Min.
3 Cups	Line 3	6 Cups	WHITE RICE: 33-38 Min. BROWN RICE: 75-80 Min.
4 Cups	Line 4	8 Cups	WHITE RICE: 38-43 Min. BROWN RICE: 80-85 Min.
5 Cups	Line 5	10 Cups	WHITE RICE: 40-45 Min. BROWN RICE: 85-90 Min.
6 Cups	Line 6	12 Cups	WHITE RICE: 43-48 Min. BROWN RICE: 88-93 Min.
7 Cups	Line 7	14 Cups	WHITE RICE: 45-50 Min. BROWN RICE: 90-95 Min.
8 Cups	Line 8	16 Cups	WHITE RICE: 47-52 Min. BROWN RICE: 92-97 Min.
9 Cups	Line 9	18 Cups	WHITE RICE: 48-53 Min. BROWN RICE: 95-100 Min.
10 Cups	Line 10	20 Cups	WHITE RICE: 50-55 Min. BROWN RICE: 100-105 Min.

* Cups referenced are with the included measuring cup. The measuring cup included adheres to rice cooker industry standards and is not equal to a standard U.S. measuring cup. The included measuring cup is equal to a standard ¾ US cup.



HELPFUL HINTS

- Rinse rice before placing it into the inner pot to remove excess bran and starch. This will help reduce browning and sticking to the bottom of the pot.
- Want perfect brown rice without the wait? Use the “Delay Timer.” Simply add rice and water in the morning and set the “Delay Timer” to the number of hours when rice will be needed. See “To Use Delay Timer” on **page 10** for instructions.
- This chart is only a general measuring guide. As there are many different kinds of rice available (see “About Rice” on **page 24**), rice/water measurements may vary.



TO STEAM FOOD & SIMULTANEOUSLY COOK RICE

To steam while cooking rice, begin cooking rice by following steps 1 to 9 of “To Cook Rice” on page 5.

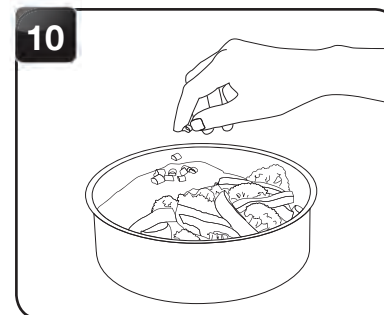

10 Place food to be steamed onto the steam tray.



11 Using caution to avoid escaping steam, open the lid.



12 Place steam tray into the rice cooker.

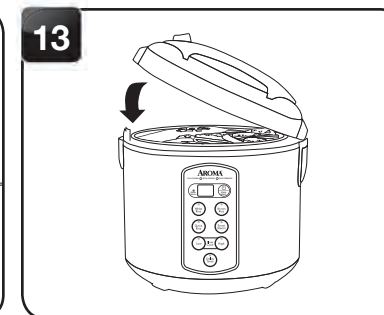

13 Close the lid securely.



NOTE

- Do not attempt to cook more than **8 cups (uncooked)** of rice if steaming and cooking rice simultaneously. The steam tray will not fit properly if more than 8 cups of rice are cooked.
- Food can be steamed at any time while rice cooks, however for best results food should be steamed toward the end of the rice cooking cycle. This will allow for rice and steamed food to be ready at the same time. See the “Rice/Water Measurement Table” on **page 8** for approximate rice cooking times.



HELPFUL HINTS

- Refer to the steaming tables for meats and vegetables on **page 19** for hints and approximate steaming times. See the “Rice/Water Measurement Table” included on **page 8** for approximate rice cooking times.



TO STEAM (CONT.)

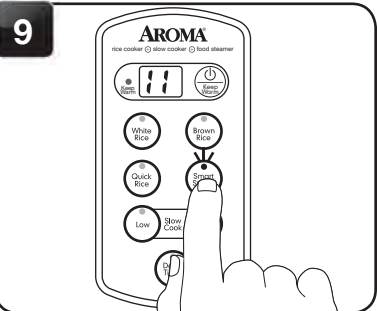

Each press of the SMART STEAM button will increase steaming time by one minute, up to 30 minutes. After 30 minutes, it will cycle back to five minutes.

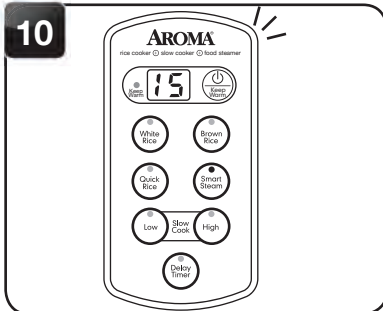

Once cooking time is selected, the rice cooker will beep to indicate it is setting at the displayed time. It will beep once more and the display will stop flashing to indicate steaming has begun.

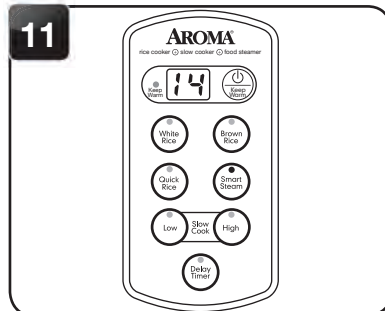

Once the water reaches a boil, the digital display will count down in one minute increments from the selected time.

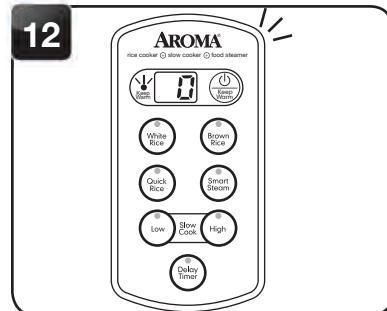

Once the selected time has passed, the rice cooker will beep and switch to "Keep-Warm" mode. The digital display will show the number of hours the rice cooker has been on "Keep-Warm," beginning with "0."

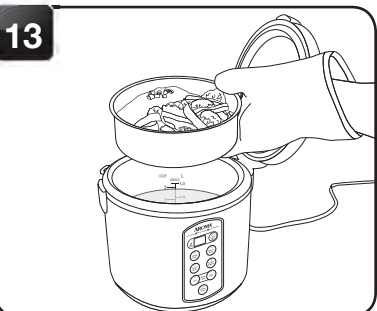

Check steamed food for doneness. If finished steaming, carefully remove the steam tray. It will be hot.

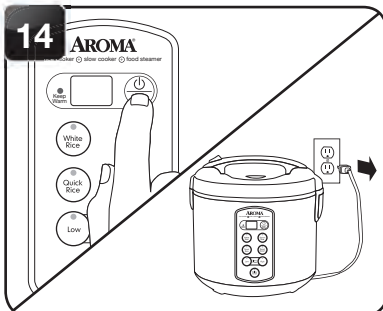

Turn the rice cooker off by pressing the POWER/KEEP-WARM button and unplug the power cord.



TO USE QUICK RICE

The rice produced by "Quick Rice" will not be to the same quality as rice made using the "White Rice" or "Brown Rice" settings, but it's an excellent option for cooked rice in a pinch.

To use the "Quick Rice" function, follow the steps for "To Cook Rice" beginning on page 5. Rather than pressing one of the standard rice function buttons, press the QUICK RICE button. If cooking brown rice, add an additional 1 1/2 cups water, using the provided measuring cup, to compensate for the lack of soaking time. The included measuring cup is equal to a standard 3/4 US cup.

WHITE RICE UNCOOKED CUPS*	COOKING TIME WITH "QUICK RICE" FUNCTION	APPROX. TIME SAVINGS COMPARED TO "WHITE RICE" FUNCTION	BROWN RICE UNCOOKED CUPS*	COOKING TIME WITH "QUICK RICE" FUNCTION	APPROX. TIME SAVINGS COMPARED TO "BROWN RICE" FUNCTION
2 Cups	17-22 Min.	15 Min.	2 Cups	38-43 Min.	25 Min.
4 Cups	22-27 Min.	15 Min.	4 Cups	44-49 Min.	35 Min.
6 Cups	27-32 Min.	15 Min.	6 Cups	46-51 Min.	40 Min.
8 Cups	30-35 Min.	10 Min.	8 Cups	52-57 Min.	40 Min.
10 Cups	38-43 Min.	10 Min.	10 Cups	57-62 Min.	45 Min.

* Cups referenced are with the included measuring cup. The measuring cup included adheres to rice cooker industry standards and is not equal to a standard U.S. measuring cup. If cooking brown rice, add an additional 1 1/2 cups water, using the provided measuring cup, to compensate for the lack of soaking time. The included measuring cup is equal to a standard 3/4 US cup.



NOTE

- Cooking times are approximate. Altitude, humidity and outside temperature will affect cooking time.
- Opening the lid during the cooking cycle causes a loss of heat and steam. Cooking time may be prolonged if the lid is opened before the rice is finished.

15 TO USE THE DELAY TIMER

Follow steps 1 to 7 of "To Cook Rice" beginning on page 5.

TO STEAM (CONT.)

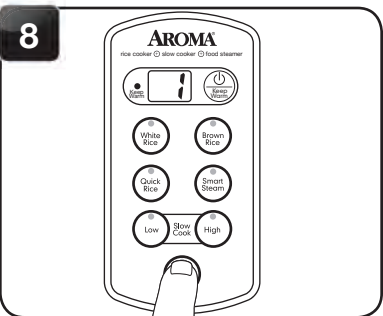

Press the DELAY TIMER button. Each press increases in one hour increments. It may be set 1 to 15 hours in advance.

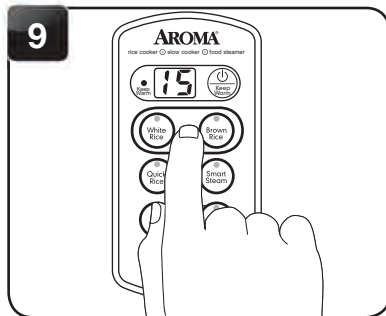

Once the needed time is selected, press the WHITE RICE or BROWN RICE button, depending upon the type of rice being cooked.

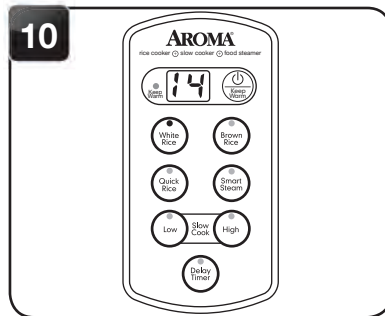

The digital display will count down from the time selected.

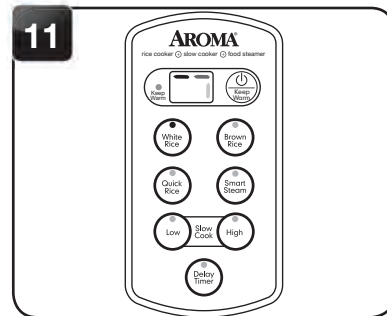

Once rice begins cooking, the digital display will show a "chasing" pattern.



Close the lid securely.

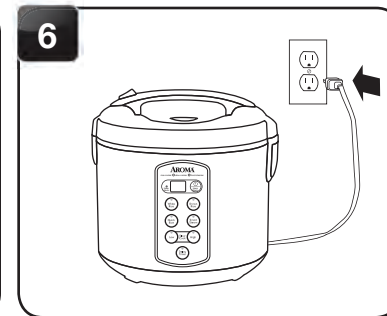

Plug the power cord into an available outlet.

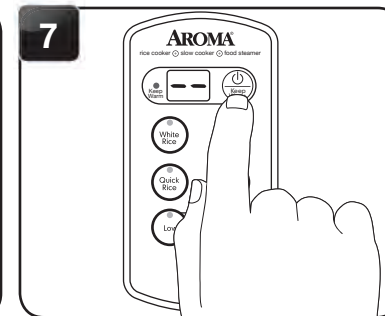

Press the POWER/KEEP-WARM button to turn the rice cooker on.

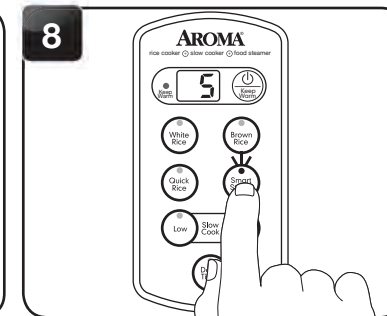

Press the SMART STEAM button. The digital display will show a flashing 5 to represent five minutes of steam time.



NOTE

- Due to the longer cooking time needed, the "Brown Rice" setting may only be delayed for 2 or more hours.



HELPFUL HINTS

- If you misplace the measuring cup, a $\frac{3}{4}$ standard US cup is an exact replacement.
- To add more flavor to rice, try substituting a favorite meat or vegetable broth or stock. The ratio of broth/stock to rice will be the same as water to rice.

TO STEAM

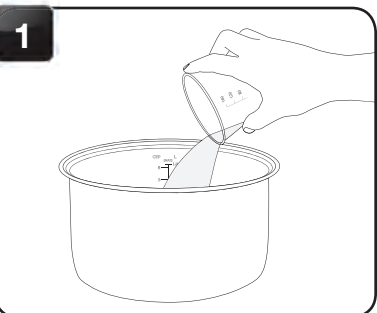

1 Using the provided measuring cup, add 3 cups water to the inner cooking pot.

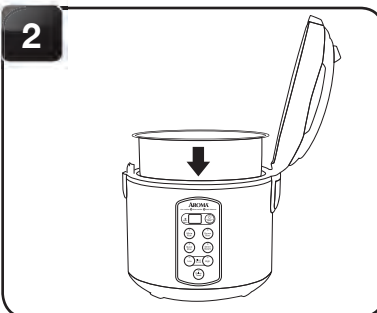

2 Place the inner cooking pot into the rice cooker.



3 Place food to be steamed onto the steam tray.

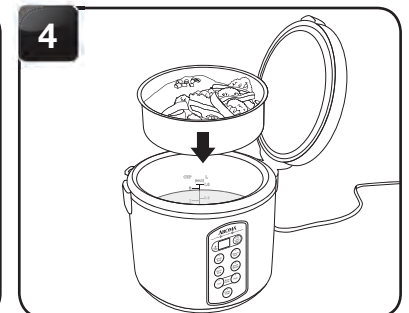

4 Place the steam tray into the rice cooker.

NOTE

- If too little water is added, the rice cooker will stop prematurely.

HELPFUL HINTS

- If you misplace the measuring cup, a $\frac{3}{4}$ standard US cup is an exact replacement.
- Smaller foods may be placed on a heat-proof dish and then placed onto the steam tray. Parchment paper or aluminum foil may be used as well. Place the paper/foil in the center of the steam tray and ensure it does not create a seal along the bottom of the steam tray. For best results, it is recommended to puncture small holes in the paper/foil.
- For suggested steaming times and water amounts, see the meat and vegetable steaming tables on **page 19**.

TO USE THE DELAY TIMER (CONT.)

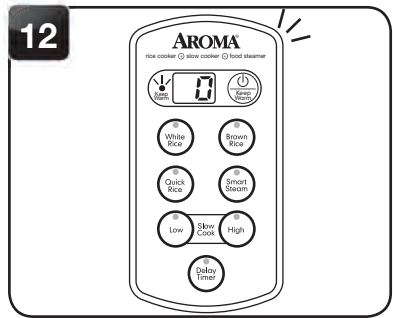

12 Once rice is finished, the rice cooker will beep and automatically switch to "Keep-Warm." The digital display will show the number of hours the rice cooker has been on "Keep-Warm," beginning with "0."



13 For better results, stir the rice with the serving spatula to distribute any remaining moisture.

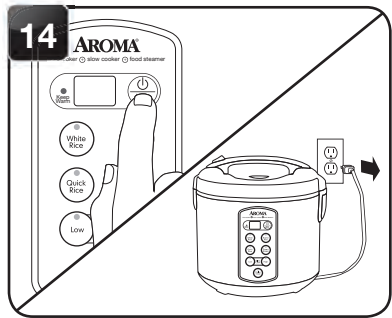

14 When finished serving rice, turn the rice cooker off by pressing the **POWER/KEEP-WARM** button and unplug the power cord.

NOTE

- Rice should not be left in the rice cooker on "Keep-Warm" for more than 12 hours.

TO SLOW COOK

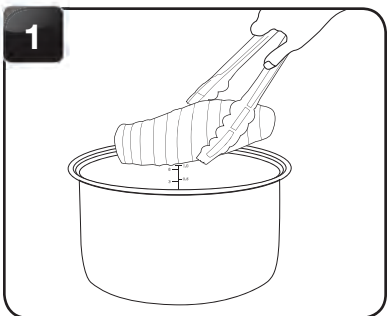

1 Add food to be slow cooked to the inner cooking pot.



2 Place the inner cooking pot into the slow cooker.



3 Close the lid securely.

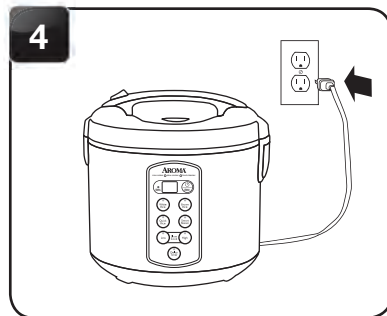

4 Plug the power cord into an available outlet.

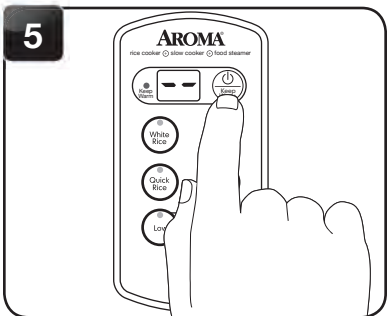

5 Press the **POWER/KEEP-WARM** button to turn the rice cooker on.

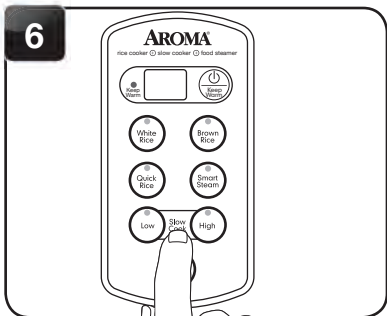

6 Press the **LOW** or **HIGH** slow cook buttons, depending upon what the recipe calls for.



NOTE

- Before placing the inner cooking pot into the rice cooker, check that the cooking pot is dry and free of debris. Adding the inner cooking pot when wet may damage the rice cooker.

TO SLOW COOK (CONT.)

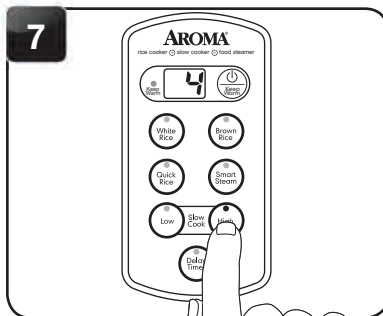

7 Each press of the **HIGH** or **LOW** slow cook buttons will increase the slow cook time by one hour. The **LOW** slow cook button will set from 6 to 10 hours; the **HIGH** slow cook button will set from 2 to 5 hours.

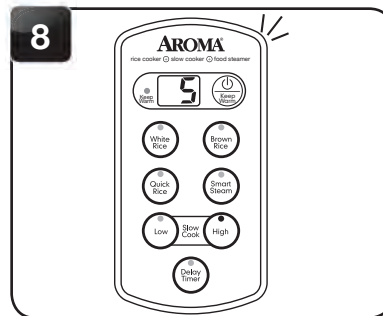

8 Once cooking time is selected, the rice cooker will beep to indicate it is setting at the displayed time. It will beep once more and the display will stop flashing to indicate cooking has begun.

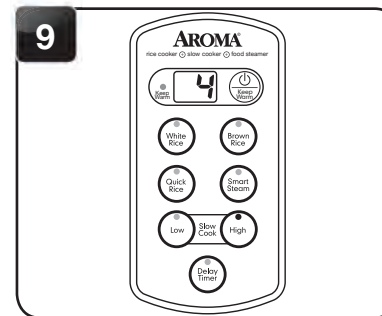

9 The rice cooker will begin to slow cook. The digital display will count down in one hour increments from the selected time.

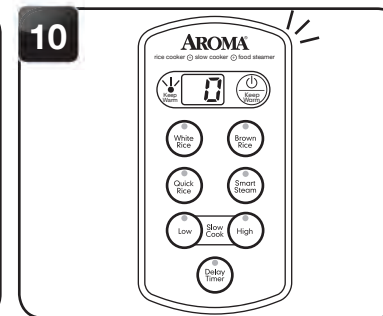

10 Once the selected time has passed, the rice cooker will beep and switch to "Keep-Warm" mode. The digital display will show the number of hours the rice cooker has been on "Keep-Warm," beginning with "0."

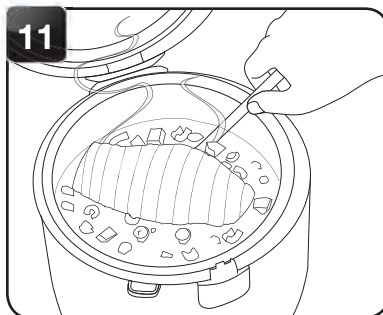

11 Open the lid to check food for doneness. If fully cooked, remove food for serving.

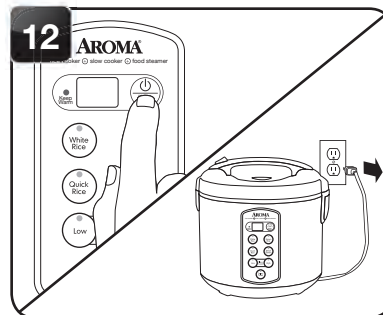

12 When finished serving, turn the rice cooker off by pressing the **POWER/KEEP-WARM** button and unplug the power cord.



NOTE

- Do not leave food on "Keep-Warm" for more than 12 hours.