

AROMA®

PROFESSIONAL™

Instruction Manual

Electric Kettle



Questions or concerns about your electric kettle?

Before returning to the store...



Aroma's customer service experts are happy to help. Call us toll-free at **1-800-276-6286**.



Answers to many common questions and even replacement parts can be found online. Visit **www.AromaCo.com/Support**.

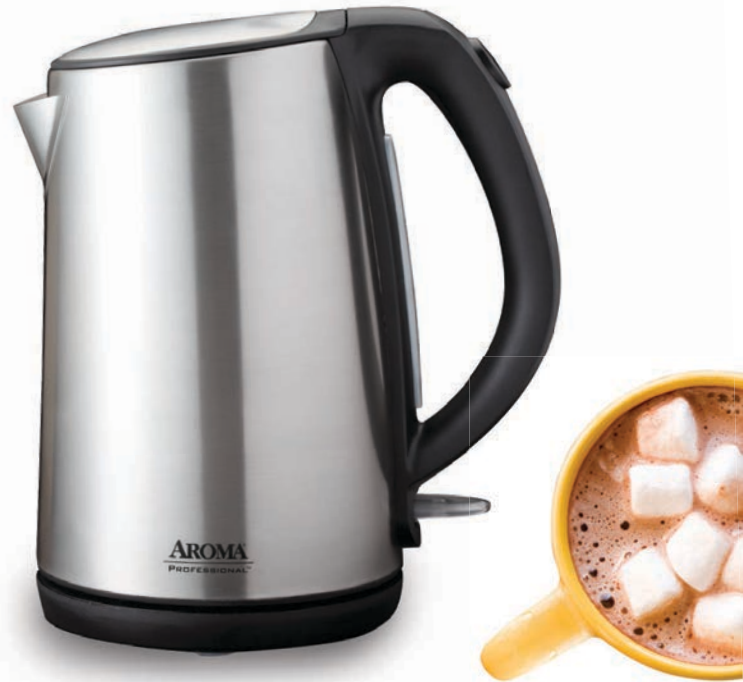



Congratulations on your purchase of the Aroma® Electric Kettle– the best way to boil! This electric kettle is the ideal solution for any need in the kitchen that calls for boiling water in a hurry. It's perfect for soothing tea, an easy bowl of noodles, an invigorating cup of instant coffee, a hearty helping of oatmeal, delicious hot chocolate and so much more.

Faster than the stovetop, your new kettle will boil water at a blazing cup-a-minute speed. And there's no need to worry about a forgotten kettle, as the electric kettle shuts off automatically once water has boiled.

The 100% stainless steel interior is perfect for boiling water for your favorite hot drinks and meals. And serving hot beverages to friends and family has never been easier as the electric kettle lifts off the power base for cordless pouring.

For more information on your Aroma® Electric Kettle, or for product service, replacement parts and other home appliance solutions, please visit us online at www.AromaCo.com.



www.AromaTestKitchen.com



AromaHousewares



AromaHousewares



AromaHousewares



AromaHousewares



Published By:
Aroma Housewares Co.
6469 Flanders Drive
San Diego, CA 92121
U.S.A.

1-800-276-6286

www.AromaCo.com

©2014 Aroma Housewares Company
All rights reserved.





IMPORTANT SAFEGUARDS

When using electrical appliances basic safety precautions should always be followed, including the following:

1. Read all instructions carefully before using the appliance.
2. Do not touch hot surfaces. Use handles or knobs. Metal surfaces become extremely hot.
3. To protect against fire, electric shock and injury to persons, do not immerse cord, plug or kettle in water or any other liquid. See instructions for cleaning.
4. Close supervision is necessary when the appliance is used by or near children.
5. Always unplug the appliance from the outlet when not in use and before cleaning. Allow the kettle to cool completely before putting on or taking off parts, and before cleaning the appliance.
6. Do not operate appliance with a damaged cord or plug, or after appliance malfunctions or has been damaged in any manner. Contact Aroma® customer service for examination, repair or electrical/mechanical adjustment.
7. The use of accessory attachments not recommended by Aroma® Housewares may result in fire, electrical shock or injury.
8. Do not use outdoors.
9. Do not let cord hang over the edge of a table or counter or to touch hot surfaces.
10. Do not place kettle on or near a hot gas or electric burner or in a heated oven.
11. To disconnect, turn any control to the "OFF" position, then remove the plug from the wall outlet.
12. Do not use kettle for other than its intended use.
13. The power base must only be used with the provided kettle.
14. Only use the kettle to heat water. No other liquids should be placed inside the kettle.
15. Do not unscrew any screws on the kettle or power base or attempt to disassemble them in any way.
16. Do not move kettle during the heating process.
17. This appliance is for household use only.
18. Do not immerse this appliance or any of its parts in water.
19. Scalding may occur if the lid is removed during the boiling cycle.
20. **Caution:** If water exceeds the "MAX" line, the boiled water may spill out.
21. Use only on a level, dry and heat-resistant surface.
22. Always unplug from the base of the wall outlet. Never pull on the cord.
23. The electric kettle should be operated on a separate electrical circuit from other operating appliances. If the electrical circuit is overloaded with other appliances the electric kettle may not operate properly.
24. Do not open the kettle lid when in operation.

SAVE THESE INSTRUCTIONS



IMPORTANT SAFEGUARDS

Short Cord Instructions

1. A short power-supply cord is provided to reduce the risks resulting from becoming entangled in or tripping over a longer cord.
2. Longer extension cords are available and may be used if care is exercised in their use.
3. If a longer extension cord is used:
 - a. The marked electrical rating of the extension cord should be at least as great as the electrical rating of the appliance.
 - b. The longer cord should be arranged so that it will not drape over the counter top or tabletop where it can be pulled by children or tripped over unintentionally.

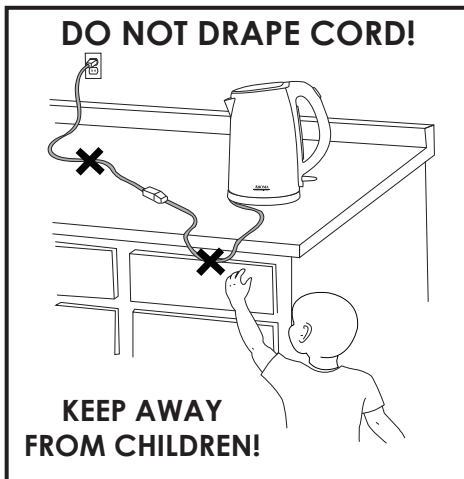

Polarized Plug

This appliance has a **polarized plug** (one blade is wider than the other); follow the instructions below:

To reduce the risk of electric shock, this plug is intended to fit into a polarized outlet only one way. If the plug does not fit fully into the outlet, reverse the plug. If it still does not fit, contact a qualified electrician. Do not attempt to modify the plug in any way.

If the supply cord is damaged, it must be replaced by the manufacturer, its service agent or a similarly qualified person in order to avoid a hazard.



PARTS IDENTIFICATION

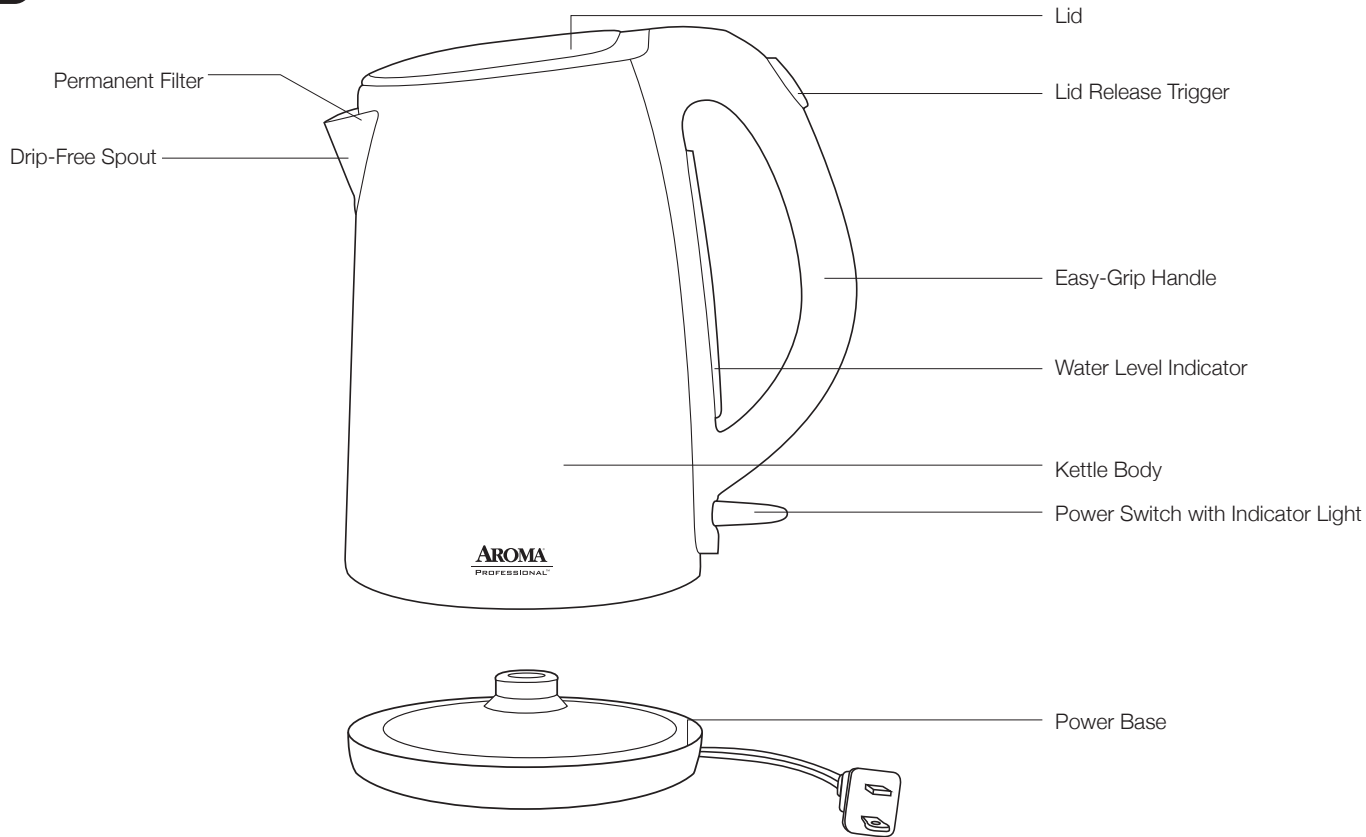



BEFORE FIRST USE

Before using for the first time, it is recommended to clean the interior of the kettle thoroughly. Please follow the procedures below before using the kettle:

1. Remove all packing materials and make sure that the product has been received in good condition.
2. Taking care to keep the electrical components on the exterior of the kettle dry, wipe the interior of the kettle with a damp cloth. If your hand will not fit inside the kettle, swish warm, soapy water around in the interior of the kettle with the lid closed.
3. Rinse out the inside of the kettle thoroughly with water.
4. With a damp cloth, gently wipe off the exterior of the kettle. Do not wipe electrical components as this may cause damage to the unit.
5. Dry all parts completely.
6. **It is recommended to run your kettle through one boiling cycle before using it to consume beverages.** Following the instructions in “To Boil Water” on **page 5**, boil a full kettle of water. When water has boiled, pour it out and rinse the inside of the kettle once more. The kettle is now ready for use.



TO BOIL WATER

1

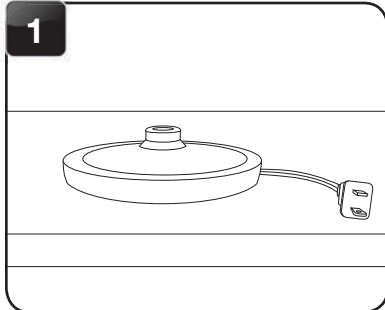

Place power base on a sturdy, level and dry surface.

2

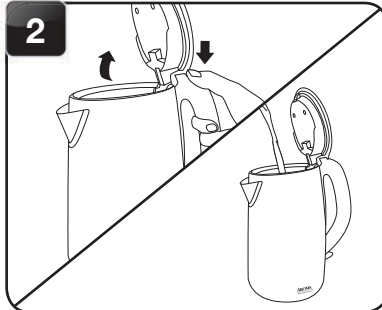

Press the **LID RELEASE TRIGGER** to open the kettle lid and fill with water through the lid opening. Water must be filled between the “Min” and “Max” levels inside the kettle.

3



Close the lid, ensuring it locks into place.

4



Place the kettle onto the power base.



CAUTION

- The stainless steel portions of the kettle will become extremely hot during use and remain hot for sometime after. **Do not touch the stainless steel body until the kettle has cooled completely.**



TO BOIL WATER (CONT.)

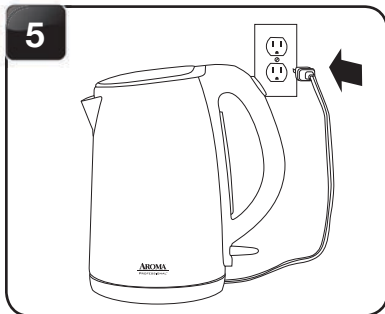

5 Plug the power cord into an available outlet.

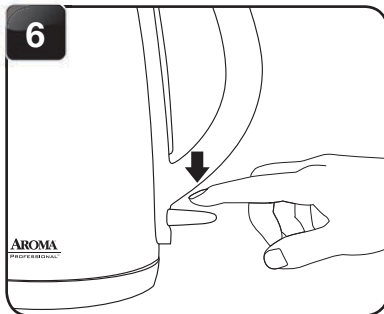

6 Press down on the **POWER SWITCH**. The **POWER SWITCH** will illuminate and the kettle will begin heating the water.

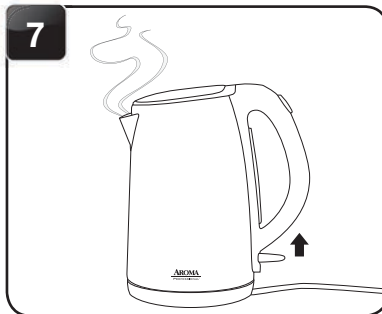

7 Once the water reaches a boil, the **POWER SWITCH** will flip up and the kettle will automatically shut off.



8 Using the easy-grip handle, lift the kettle off the power base to serve. Do not touch the stainless steel body, as it will be hot.

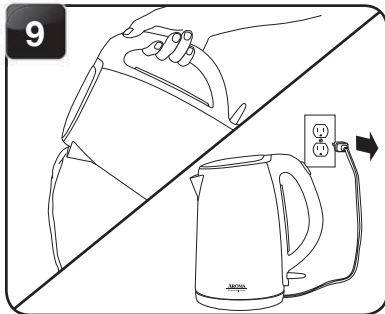

9 When finished serving, pour out any remaining water and unplug the power cord.



NOTE

- Never fill kettle with any liquid other than water.
- Never open the lid while water is boiling.
- If the kettle is heated with no water, the internal safety mechanism will automatically turn the kettle off. The **POWER SWITCH** will automatically return to the OFF position. The kettle will begin working again after the kettle is removed from and returned to the base and the internal temperature drops to a safe level. The kettle functions properly when water is added.



TO CLEAN

Always unplug the kettle and allow it to cool completely before cleaning.



1 Wipe the exterior of the kettle with a damp cloth, taking care to avoid the electrical components.

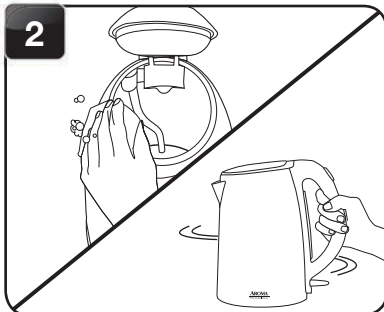

2 Clean the interior of the kettle with a soft sponge and warm, soapy water. If your hand does not fit in the lid opening, swish warm, soapy water around inside the kettle with the lid closed.

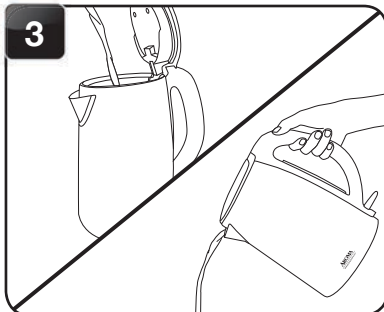

3 Rinse any remaining soapy water from the kettle. Drain.



NOTE

- Never attempt to disassemble the kettle or the power base.
- Never immerse the kettle, power cord, plug or power base in water.
- Always take care not to allow electrical components to come into contact with water.
- Do not use abrasive cleaners or scouring pads of any kind on the kettle or power base. This will cause damage to the finish and may create a risk of electrical shock.
- Any other servicing should be performed by Aroma® Housewares.



REMOVING MINERAL DEPOSITS

Hard water can leave mineral deposits that create scale build-up on the interior of the kettle. If mineral deposits occur, follow these steps:

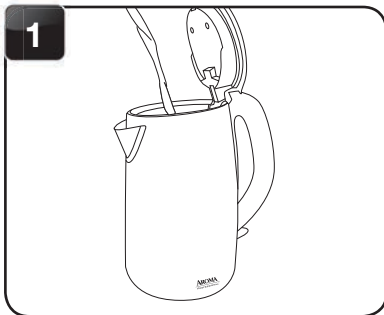

1 Fill the kettle half full with water.

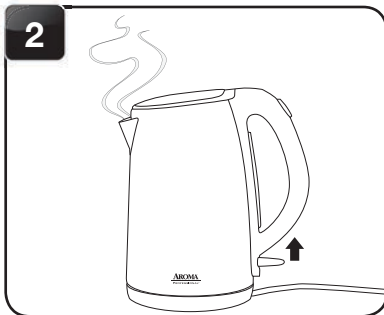

2 Following the instructions in “To Boil Water” on page 5, bring the water to a boil.

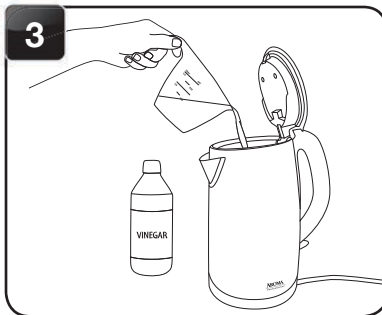

3 Add one cup of white vinegar to the water in the kettle.

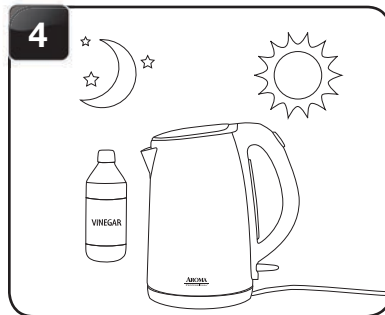

4 Allow the mixture to soak overnight.

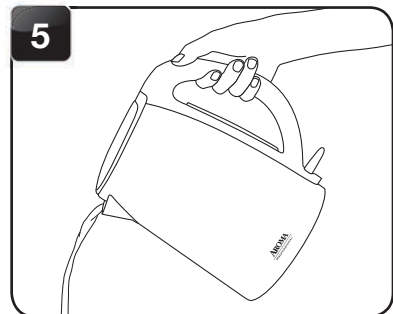

5 Empty the mixture and rinse out the kettle.

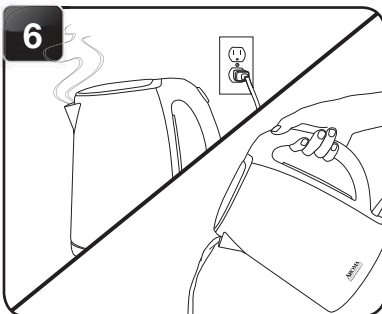

6 Refill the kettle with water only. Bring it to a boil and empty again. Repeat as needed.



HELPFUL HINT

- Using distilled water will help to prevent the buildup of mineral deposits.



TROUBLESHOOTING

<p>The kettle and indicator light do not work when the POWER SWITCH is down.</p>	<ul style="list-style-type: none">• Make sure the kettle is seated properly on the power base and that the base is connected to a functioning electrical outlet.• If the kettle is heated with no water, the internal safety mechanism will automatically turn the kettle off. The POWER SWITCH will automatically return to the OFF position. The kettle will begin working again after the kettle is removed from and returned to the base and the internal temperature drops to a safe level. The kettle functions properly when water is added.• If the problem persists, please contact our customer service department toll-free at (800) 276-6286 or through email at CustomerService@AromaCo.com.
<p>The water is boiling, but the POWER SWITCH and indicator light do not turn off.</p>	<ul style="list-style-type: none">• The auto shut-off function will not operate properly if the lid is not completely closed. Allow kettle to cool, then check to see that the the lid is properly locked into place.• If the problem persists, please contact our customer service department toll-free at (800) 276-6286 or through email at CustomerService@AromaCo.com.
<p>The POWER SWITCH won't depress and the kettle will not turn on.</p>	<ul style="list-style-type: none">• Make sure that the kettle is seated properly on the power base and that the base is connected to a functioning electrical outlet.• Water or debris on the bottom of the kettle or on the power base may interfere with the functioning of the kettle. Be sure that the base of the kettle and the power base are dry and free of debris.• If the problem persists, please contact our customer service department toll-free at (800) 276-6286 or through email at CustomerService@AromaCo.com.
<p>There are mineral deposits on the interior of the kettle.</p>	<ul style="list-style-type: none">• A certain amount of scale build-up is normal after long periods of use and is caused by minerals contained in hard water. The best way to prevent mineral deposits is to always use distilled water in the kettle.• To remove deposits, try filling the kettle halfway with water and adding a few slices of lemon, then boil. If this does not work, please see the section on page 8 entitled "Removing Mineral Deposits."



LIMITED WARRANTY

LIMITED WARRANTY

Aroma Housewares Company warrants its products against defects in material and workmanship for five years from provable date of purchase in the United States.

Within this warranty period, Aroma Housewares Company will repair or replace, at its discretion, defective parts at no charge, provided the product is returned, freight prepaid with proof of purchase and U.S. \$15.00 for shipping and handling charges payable to Aroma Housewares Company. Before returning an item, please call the toll free number below for a return authorization number. Allow 2-4 weeks for return shipping.

This warranty does not apply if the warranty period expired; the products has been modified by any unauthorized service center or personnel; the defect was subject to abuse, improper use not conforming to product manual instructions, or environment conditions more severe than those specified in the manual and specification, neglect of the owner or improper installation; the defect was subject to Force Majeure such as flood, lightning, earthquake, other natural calamities, war, vandalism, theft, brownouts or sags (damage due to low voltage disturbances).

This warranty gives you specific legal rights, which may vary from state to state, and does not cover areas outside the United States.

AROMA HOUSEWARES COMPANY
6469 Flanders Drive
San Diego, California 92121
1-800-276-6286
M-F, 8:30 AM - 4:30 PM, Pacific Time
Website: www.AromaCo.com

SERVICE & SUPPORT

In the event of a warranty claim, or if service is required for this product, please contact Aroma® customer service toll-free at:

1-800-276-6286
M-F, 8:30AM-4:30PM, Pacific Time

Or we can be reached online at CustomerService@AromaCo.com.

For your records, we recommend stapling your sales receipt to this page along with a written record of the following:

Date of Purchase: _____

Place of Purchase: _____



NOTE

- Proof of purchase is required for all warranty claims.